

**FREE STANDING
TISSUE HOLDER-SQUARE
KFS-SQ-TP**

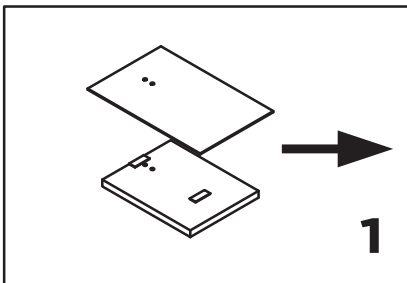

Take out parts 4 & 5.

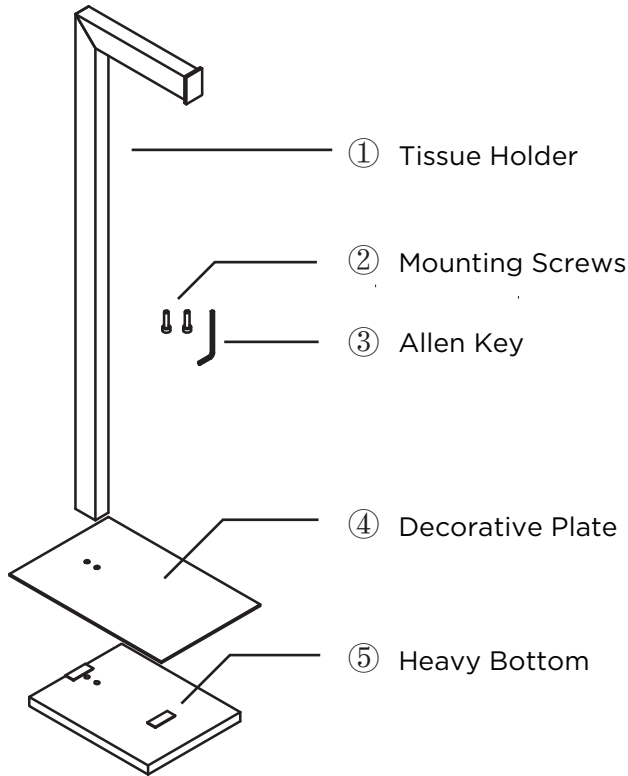
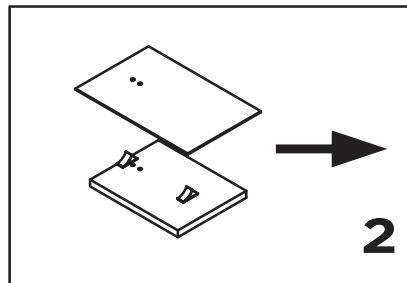

Tear off the double-sided adhesive tape on part 5 (heavy bottom).

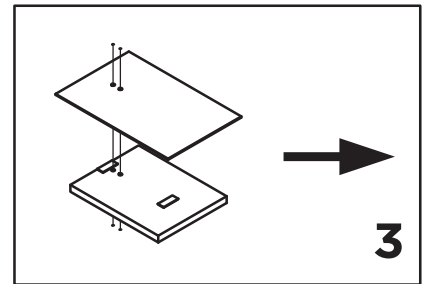

Align the mounting holes in the heavy bottom 5 and decorative plate 4, stick them together by force.

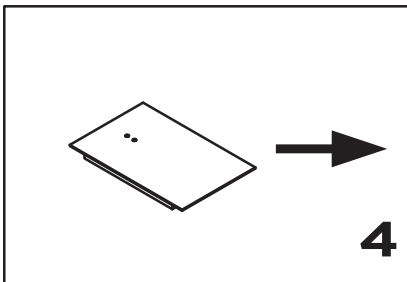

Bottom parts installation is finished.

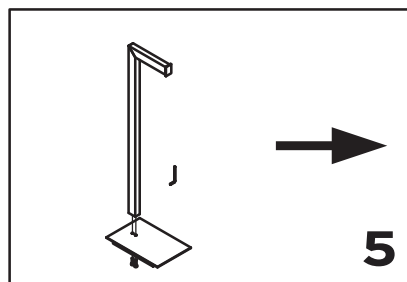

Align the tissue holder to the mounting holes on the bottom part, and use the Allen key to screw through from the back of the bottom and tighten it.

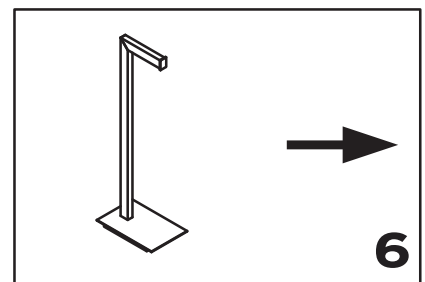

Finish assembling.