

## Features

- Single-speed whirlpool offers performance and value, with 6 fully adjustable jets.
- Hydromassage flow and direction can be controlled at each jet.
- Built-in heater.
- Oval shape creates a graceful and spacious bathing experience.
- Molded lumbar support and armrests offer extra comfort while bathing.
- Multiple pump location options give you more choices for installation and access. (See specification sheet for pump locations.)
- End drain.
- Under-mountable

## Material

- Acrylic

## Hydrotherapy

- Whirlpool

## Installation

- Drop-in or under-mount.

## Recommended Products/Accessories

K-11677 Bath Drain  
K-7213 27" Cable Bath Drain  
K-7214 27" Cable Bath Drain  
K-24916 Wireless Music Kit  
K-576 Under-Mount Installation Kit  
K-1491 Bath/Whirlpool Pillow  
K-1601 Bath/Whirlpool Footstop



## Codes/Standards

ASME A112.19.7/CSA B45.10  
CSA B45.5/IAPMO Z124  
ASTM E162  
ASTM E662  
UL 1795



**KOHLER® Plastic Baths and Receptors  
Lifetime Limited Warranty  
KOHLER® Hydrotherapy Components  
Five-Year Limited Warranty**

See website for detailed warranty information.

## Available Colors/Finishes

*Color tiles intended for reference only.*

### Color Code Description

	0	White
	96	Biscuit
	47	Almond

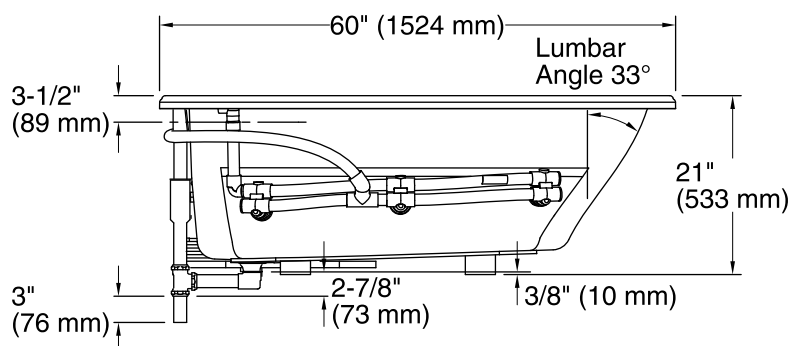
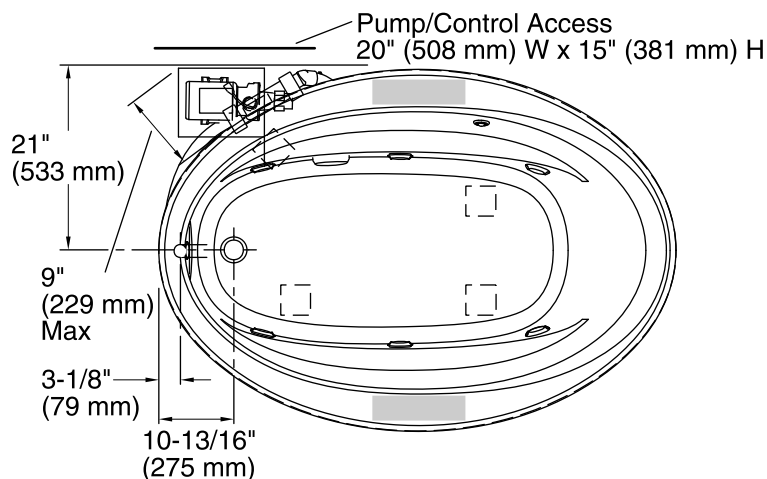

No change in measurements if connected with drain illustrated. (K-11677)

Recommended faucet area

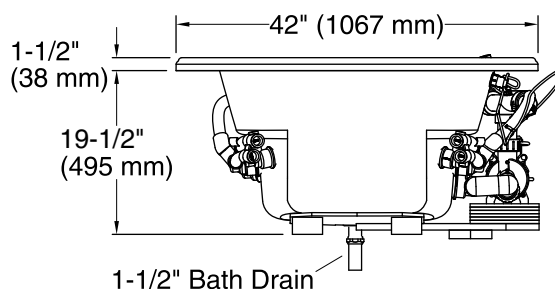
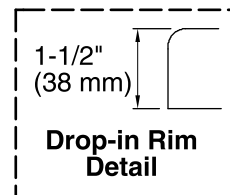

### Required Electrical Service

Two dedicated circuits required, protected with Class A Ground-Fault Circuit-Interrupter (GFCI). Outside North America, this device may be known as a Residual Current Device (RCD).

Pump: 120 V, 15 A, 60 Hz  
Heater: 120 V, 15 A, 60 Hz

### Technical Information

All product dimensions are nominal.

Installation: Drop-in  
Drain location: End  
Basin area, bottom: 43" x 21-9/16" (1092 mm x 548 mm)  
Basin area, top: 53-1/2" x 32-1/8" (1359 mm x 816 mm)  
Weight: 110 lbs (49.9 kg)  
Minimum floor load: 35 lbs/ft<sup>2</sup> (170.9 kg/m<sup>2</sup>)  
Water depth: 15" (381 mm)  
Water capacity: 57 gal (215.8 L)  
Template: Drop-in, 1042556-7, required, included  
Electrical component rating: Pump: 120 V, 7.5 A, 60 Hz  
Heater: 120 V, 12.5 A, 60 Hz, 1500 W  
Pump speed: Single

### Notes

Measure your actual product for rough-in details. Install this product according to the installation instructions.

The hot water supply should be 70% of the capacity of the bath or greater. Installations will vary.

Provide one grounded electrical outlet within 24" (610 mm) of each component.

Kit is required for under-mount installations (sold separately).

The pump base extends 9" (229 mm) beyond the edge of the rim. Modify the framing as needed.