

Features

- Low-threshold design for easy entry and exit.
- Molded-in textured floor.
- Water containment bead incorporated into the threshold design provides an optimum barrier, eliminating water escaping from the shower space.
- Single threshold for alcove installation.
- Durable acrylic construction.
- Left-hand drain.
- Coordinates with Choreograph® shower walls and other KOHLER collections.



Recommended Products/Accessories

K-9132 Shower Drain

Codes/Standards

CSA B45.5/IAPMO Z124

ASTM E162







ASTM E662

KOHLER® Plastic Baths and Receptors Lifetime Limited Warranty

See website for detailed warranty information.

Available Colors/Finishes

Color tiles intended for reference only.

Color	Code	Description
	0	White
	96	Biscuit
	47	Almond
	NY	Dune
	95	Ice™ Grey
	G9	Sandbar

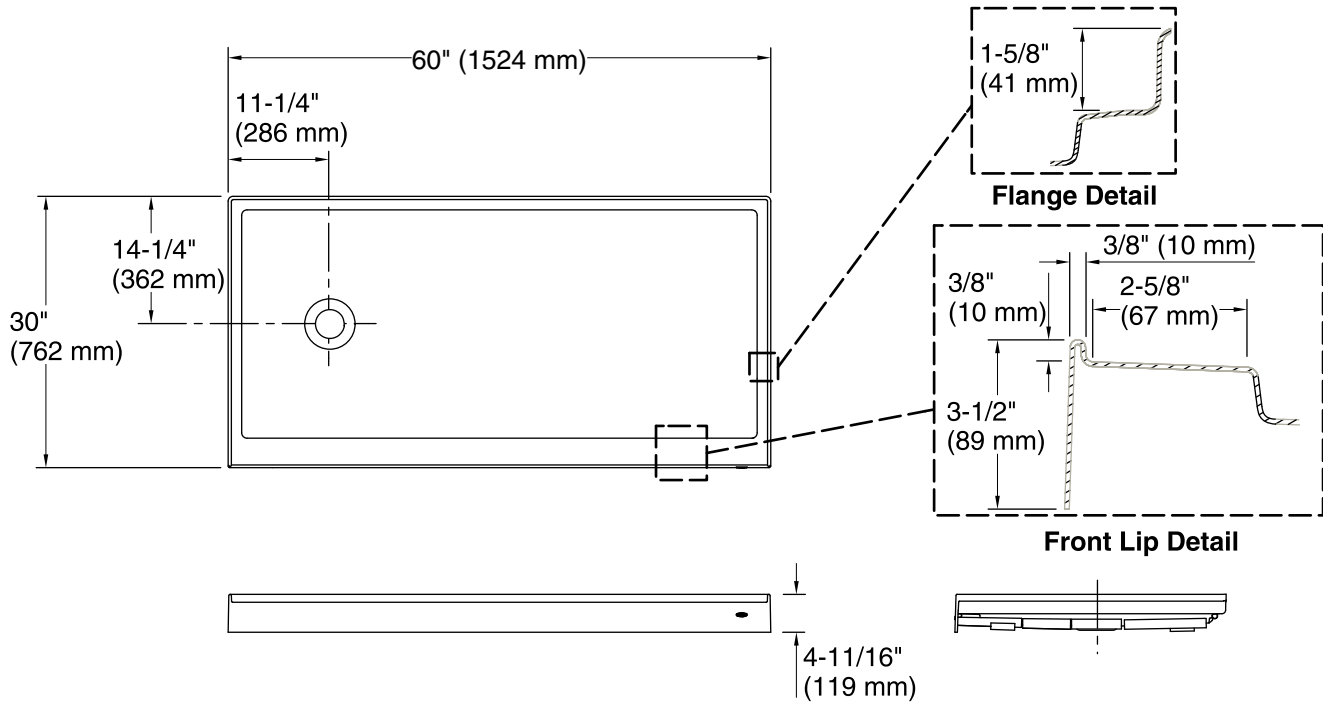

Technical Information

All product dimensions are nominal.

Installation: Three-wall alcove
 Drain location: Left
 Weight: 59 lbs (26.8 kg)

Notes

Measure your actual product for rough-in details. Install this product according to the installation instructions.
 Subfloor must be within 1/2" (13 mm) of level. This receptor has a front lip. This should be taken into account when installing a shower door.