

Encore - 30"

Specification & Installation Guide

Features

- Free Standing 30" vanity: 34" (864mm)H x 22"(560mm)D x 29-5/8" (753mm)W
- Furniture grade plywood layered with solid wood veneer and protected with several coats of polyurethane.
- Matching finish inside out.
- Two doors with soft-close hardware.
- One interior drawer with full-extension soft-close hardware.
- 5" center-to-center pre-drilled holes for handles.
- Handles furnished separately for field installation.
- Handle finish options: polished chrome (PC), brushed nickel (BN), polished nickel (PN), matte black (MB) and satin brass (SB)

Colors/Finishes

- Brandy (BR)
- Matte White (MW)
- Sapphire (SA)
- Studio Grey (TG)

Top/Basin options

- Glossy White X-Stone 2"H top/basin
- Glossy White X-Stone 4-1/2" H Trough sink
- Quartzstone 3/4"H countertop with undermount ceramic basin
- Quartzstone 3"H countertop with undermount ceramic basin

Package Dimensions

34" x 26" x 36"

Weight

115 lbs/52 kgs.

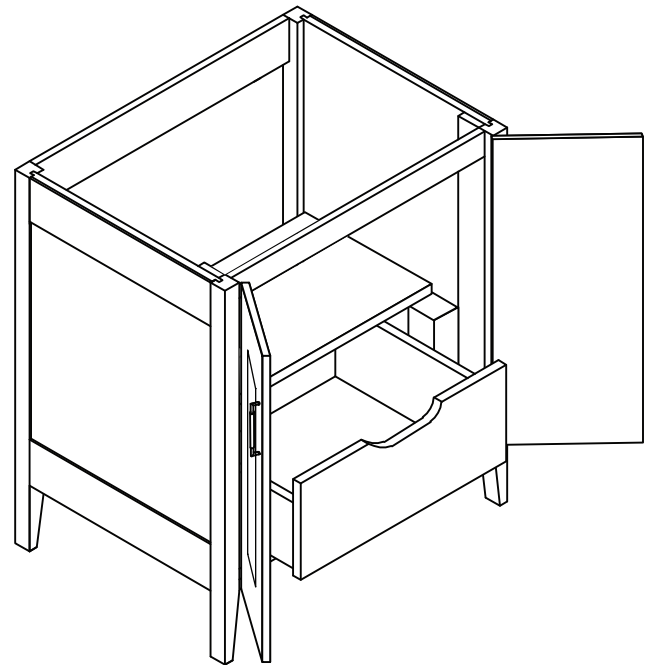
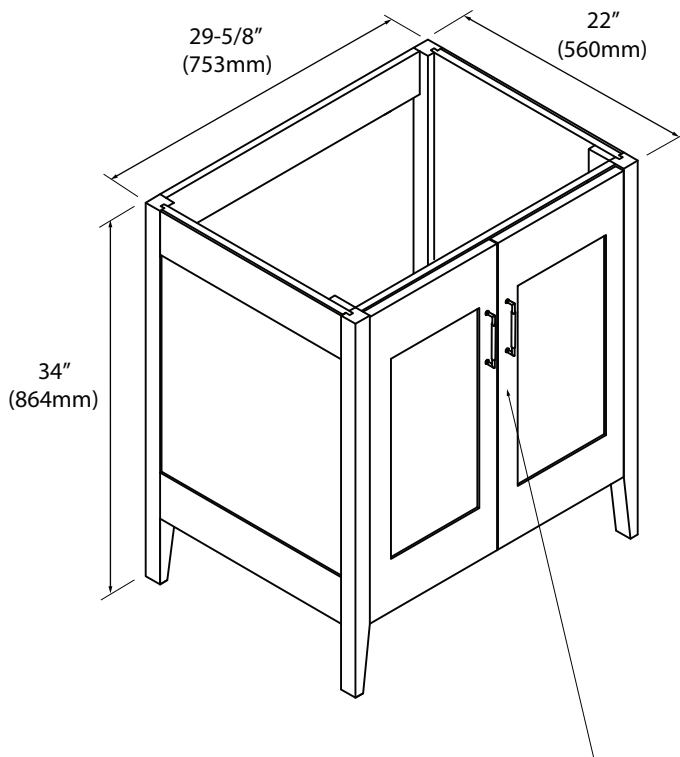

Handles furnished separately for field installation.
(5" center-to-center pre-drilled holes)

Encore - 30"

Specification & Installation Guide

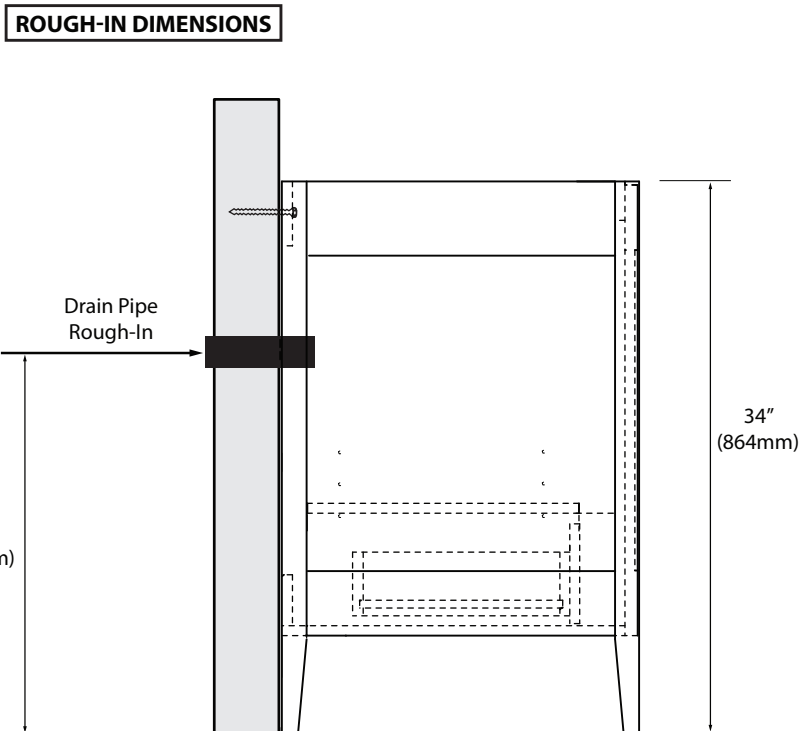
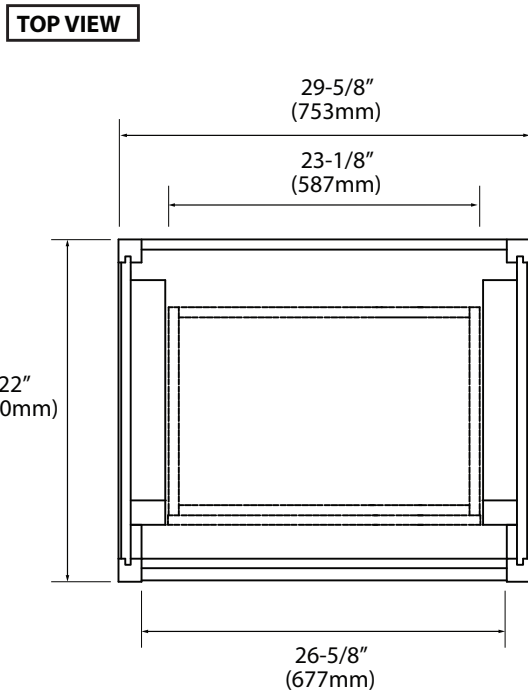
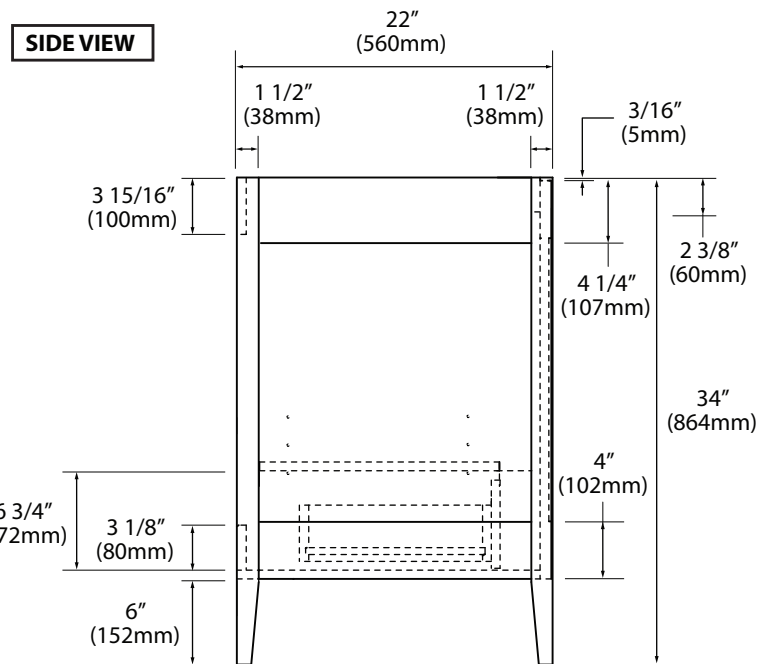
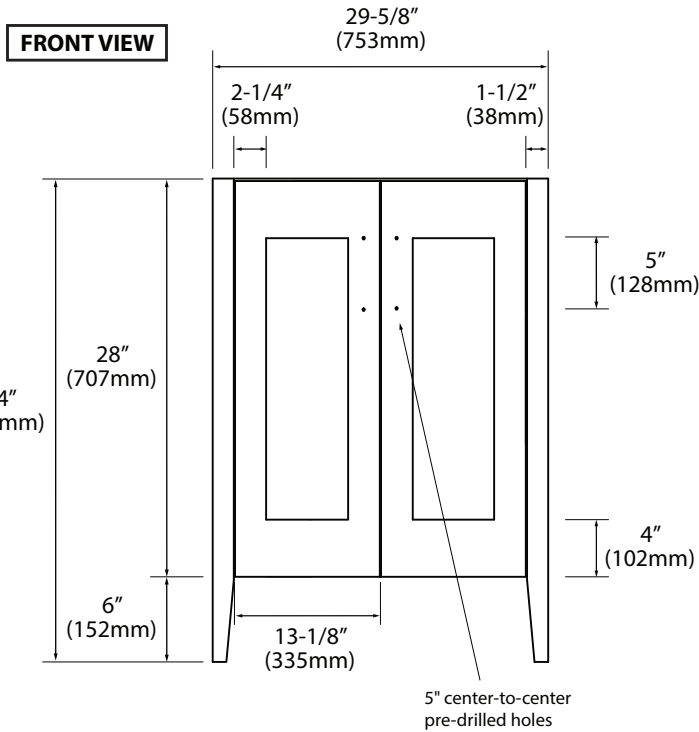

CABINET PLACEMENT & INSTALLATION - SECURE CABINET TO WALL

- 1) Level cabinet in position
- 2) Secure cabinet with screws in drywall studs
- 3) Install countertop with silicone

