

CRESCENT MCFS-652SB

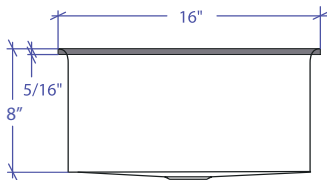

*Flush-Mount Installation Kit is included with each sink
*Custom ADA compliant versions are available

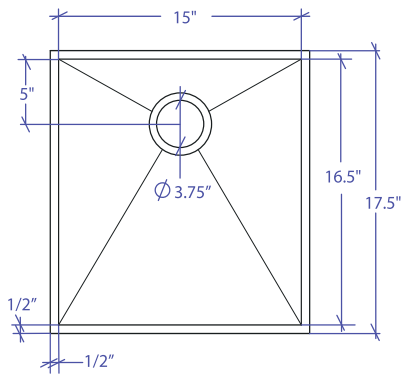

• FEATURES

- 16-gauge type 304 stainless steel
- Hollow 304 stainless steel support beam
- 1/4" round profile basin

• TECHNICAL INFORMATION

- External dimension: 16"Lx17.5"Wx8"D
- Basin dimensions: 15"Lx16.5"Wx8"D
- Frame width: 1/2"
- Frame thickness: 5/16"

• FINISHES

- Satin Brushed stainless steel

• INSTALLATION OPTIONS

- Flush-mount

• MINIMUM CABINET SIZE (I.D.)

- Flush-mount 19"

• INDUSTRY'S ONLY STAINLESS STEEL SINK DESIGNED SPECIFICALLY TO BE FLUSH-MOUNTED

• INTERNATIONAL PATENT PENDING

• FLUSH-MOUNT INSTALLATION

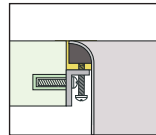

Flush-mount

• ACCESSORIES

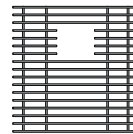

MBG-6502SB
Basin Grid

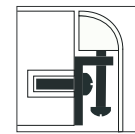

Flush Mount Kit
(Included)
MTK-615AL

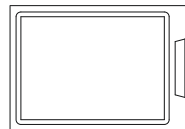

MCB-651BB
Cutting Board

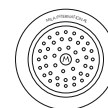

MKD-101SB
Strainer

PROJECT INFORMATION			
Project			
Date	/ /	QTY	
Specifier			
Contact			
Note			