

FLATIRON MUS-654GDSB

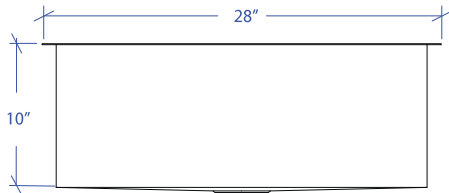

*Custom ADA compliant versions are available

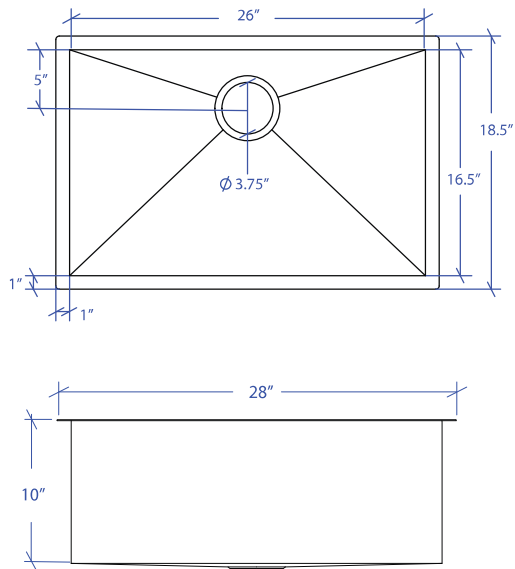

• FEATURES

16-gauge type 304 stainless steel
90° zero radius design

• TECHNICAL INFORMATION

External dimension: 28"Lx18.5"Wx10"D
Basin dimensions: 26"Lx16.5"Wx10"D

• FINISHES

Gold PVD Satin Brushed stainless steel

• INSTALLATION OPTIONS

Top-mount
Under-mount

• MINIMUM CABINET SIZE (I.D.)

Top-mount 29"
Under-mount 31"

• DUAL-MOUNT INSTALLATION

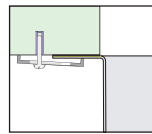

Under-mount

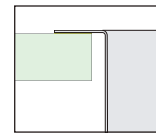

Top-mount

• ACCESSORY OPTIONS

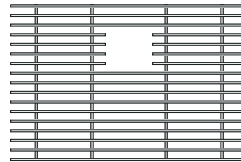

MBG-6510GDSB
Basin Grid



MCB-651BB
Cutting Board

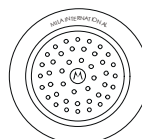

MKD-101GDSB
Strainer

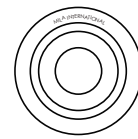

MDC-101GDSB
Disposal Collar

PROJECT INFORMATION

Project			
Date	/	/	QTY
Specifier			
Contact			
Note			