

ENC4A-36.0x20.0

Height: 36.0

Width: 20.0

Depth: 10.0

Weight HO: kg

EO: kg

Tube ϕ : 1.25

Pipe Centres: 17.0

Elec. element if specified: 200

Output @ 50°C Δ T Watts: N/A

BTUs: N/A

All dimensions in inches

Manufactured from ISO/CEN CuZn36As (BS CZ126) brass tube, inset radiator manufactured from Mild Steel

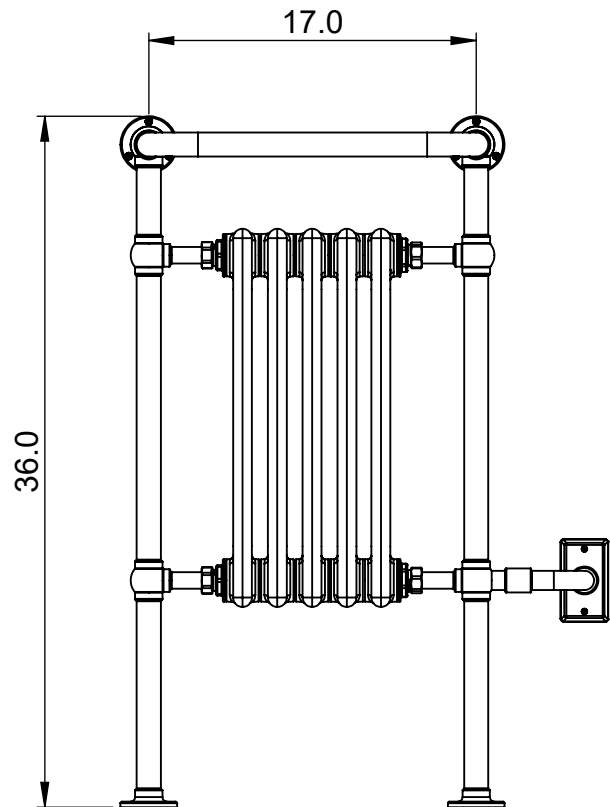
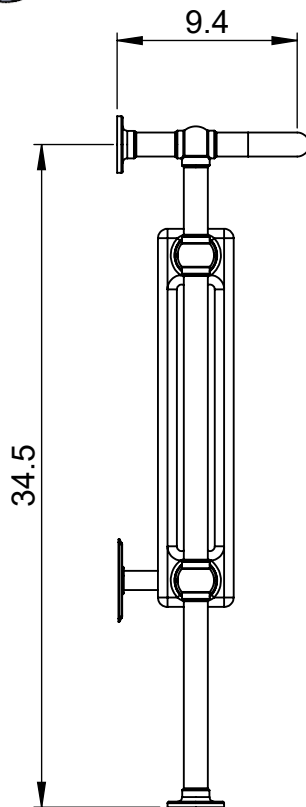
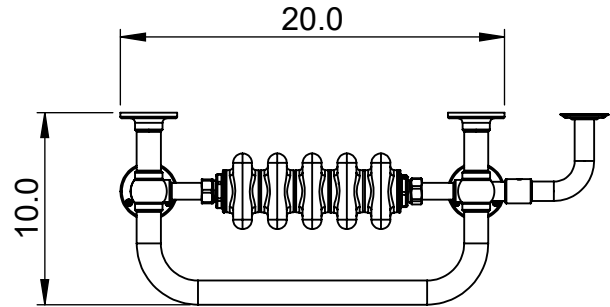
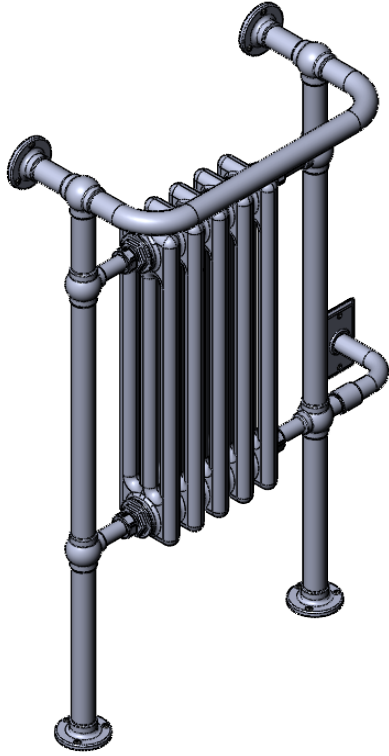

Vogue UK Ltd. reserve the right to alter specifications without prior notice.
ALL MEASUREMENTS ARE NOMINAL DIMENSIONS ONLY, AND ARE NOT BINDING.
Suitable for sealed or indirect systems only.

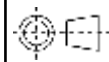

SCALE 1:10



175 Memorial Drive Unit C
Shrewsbury MA 01545 USA
Tel: 508 887 8771 Fax: 508 887 8774
e-mail: info@vougeuk.com ww.vougeuk.com