

MODERN INDUSTRIAL 6" CABINET PULL

HMP-0600

• FITS MATERIALS FROM 1/4" TO 1-1/2" THICK

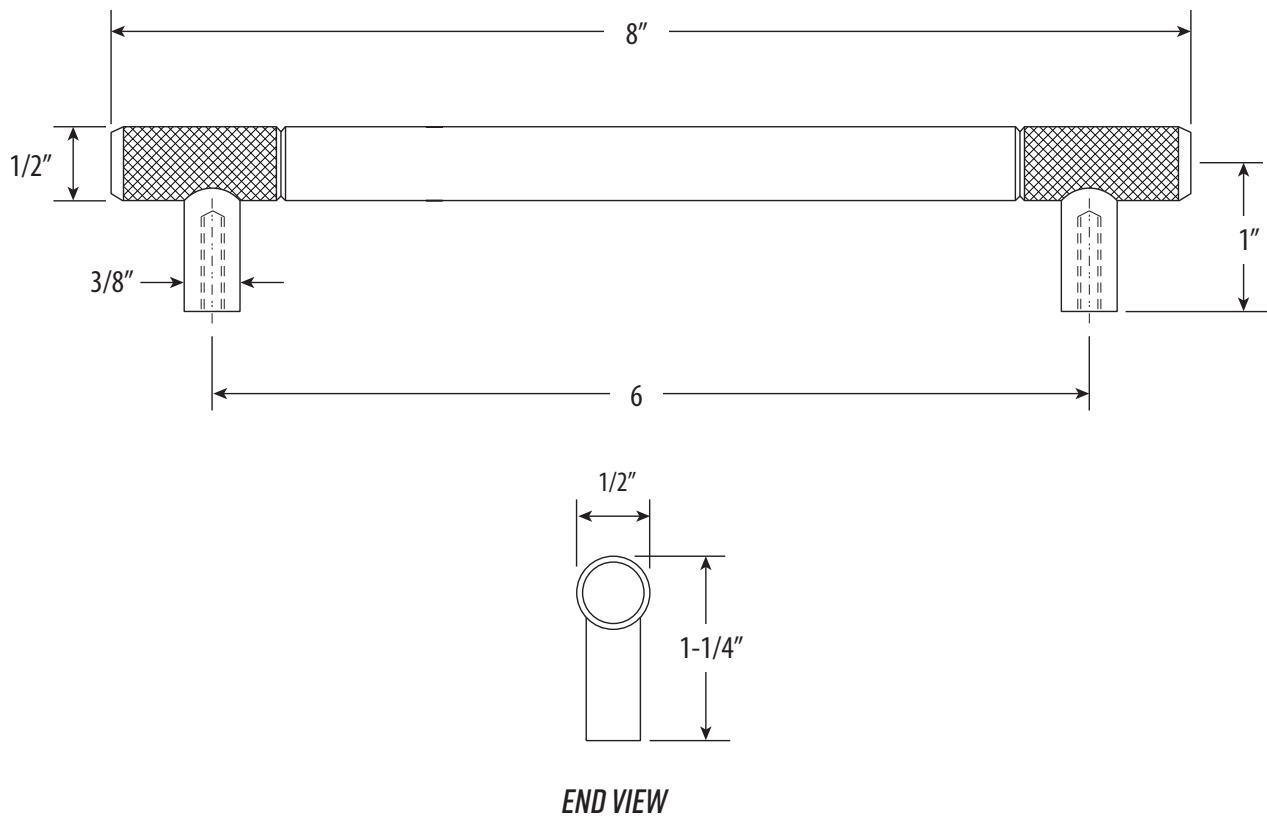

END VIEW



DIMENSIONS MAY VARY AND ARE SUBJECT TO CHANGE. NO RESPONSIBILITY IS ASSUMED FOR USE OF SUPERCEDED OR VOIDED DATA